

Palm Grip B10



The Palm Grip B10 has different equipment options for many requirements. It is compatible with our Double-handle controller or mounted on hydraulic drives. The Palm Grip has a highly flexible single wire (0,1 mm², 450 mm long). The mounting piece for the drive rod can be supplied with a tapped hole 10 mm.

Technical data

Operating temperature	-40°C to +85°C
Degree of protection	Control element up to IP67
Contact complement	1,5A 24 V DC13 (*1 0,1A 24 V DC13)



		B10AL	-3D	W	V	-X
Basic unit						
B10L	Palm Grip left					
B10R	Palm Grip right					
B10AL	Palm Grip left with growing part					
B10AR	Palm Grip right with growing part					
Digital actuating element						
D	Push Button KDA21 *1 Colour: red, black, yellow, green, blue, white, orange					
HD	Hall-Push Button (see page 158)					
W*	Rocker switch T-0-T					
W*	Rocker switch 0-T					
W*	Rocker switch R-0-T					
W*	Rocker switch R-0-R					
W*	Rocker switch 0-R					
W*	Rocker switch R-R					
*Only possible with version with attachment!						
V	Vibration pulse 24V DC ED 100%					
Special model						
X	Special / customer specified					

B10

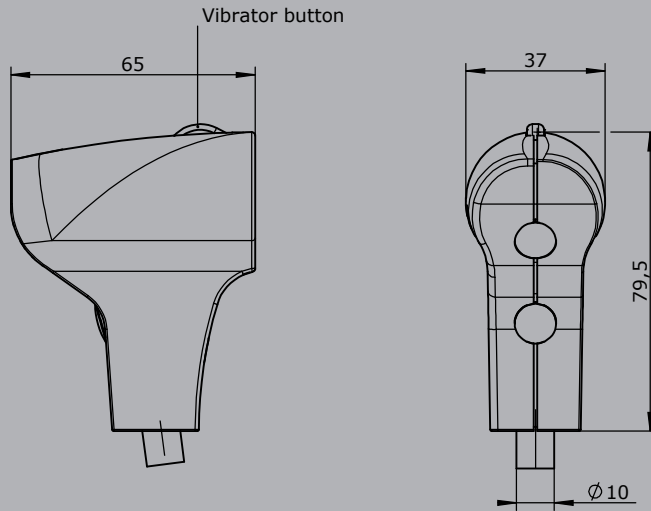

B10A

Edition installed left:
Push button installed Pos. 1,2,3
Rocker switch

Edition installed right:
Push button installed Pos. 4,5,6
Rocker switch

