

Palm Grip B5



The Palm Grip B5 has different equipment options for many requirements. It is compatible with our Multi-Axis Controller or mounted on hydraulic drives. The Palm Grip has a highly flexible single wire (4 respectively 8 x 0,25 mm², 450 mm long). The mounting piece can be supplied with a tapped hole M10 (standard) or M8.

Technical data

Operating temperature	-40°C to +85°C
Degree of protection	IP54
Contact complement	3A 24 V DC13 (*1 1,5A 24 V DC13)



	Example			
	B5	-2D	W	-X
Basic unit				
B5 Palm Grip				
Digital actuating element				
D Push Button top				
D Push Button side *5				
W Rocker switch top T-0-T				
W Rocker switch top R-0-T				
W Rocker switch top R-0-R				
T Push Button top mechanical operation <i>(Only possible in combination with Multi-Axis Controller or single-axis controller!)</i>				
Special model				
X Special / customer specified				

Edition:
Push button installed Pos. 1,2

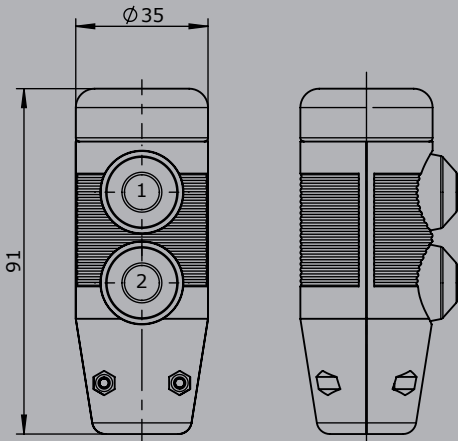

Edition:
Rocker switch installed Pos. 3
Push button installed Pos. 2

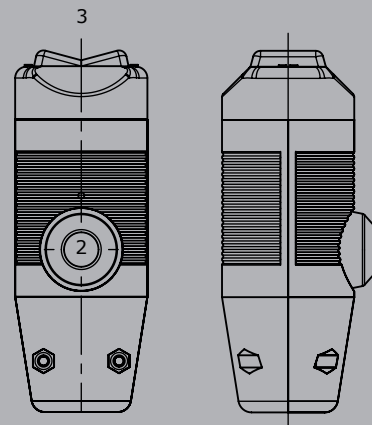

Edition:
Push button installed Pos. 2,3

